

Utilisation

27 MARS
2019

pédagogique d'Arduino : historique à Sorbonne Université

Christian Simon

Fab Lab de Sorbonne Université

christian.simon@sorbonne-universite.fr

@ChSimonSU

#JTDEF19



Sommaire

1. INTRODUCTION : ARDUINO

Les origines italiennes du « physical computing »

Le résultat : Arduino

Un contexte : les Fab Lab

La prolifération des Arduino

2. L'EXPÉRIENCE À SORBONNE UNIVERSITE

Quelles possibilités d'inter-action pour le chimiste ?

La gamme de capteurs Grove

Les enseignements développés

Instruments de chimie physique

3. L'ÉCOSYSTÈME DES MICROCONTROLEURS PÉDAGOGIQUES

Les modes de fonctionnement/les langages

Les « concurrents » d'Arduino

4. CONCLUSION

1

INTRODUCTION : ARDUINO

Les origines italiennes du «physical computing»

Bassin industriel informatique historique
(origine d'Olivetti)

Voisin du Politecnico di Torino

Interaction Design Institute Ivrea

<http://interactionivrea.org/en/index.asp>

Spécialité : Interfaces homme-machine

Liens avec le Media Lab MIT

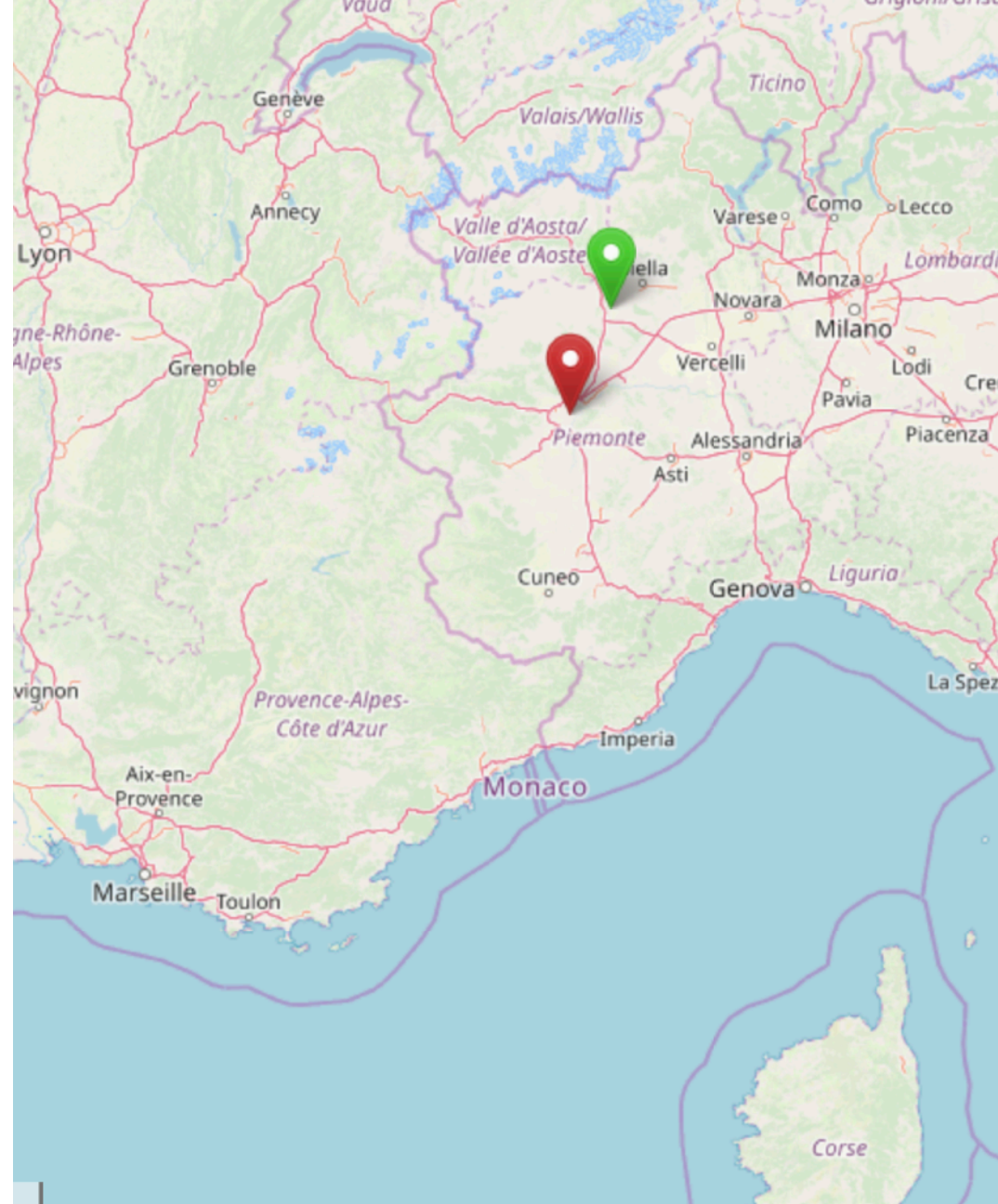

Le résultat : Arduino

Une plateforme de développement

Open-source

Peu chère

Facile à répliquer

Robuste

Modulaire

Pas d'OS (pas de système exploitation)

Facile à programmer

Par les designers, pour des designers non-
ingénieurs, des artistes, etc.

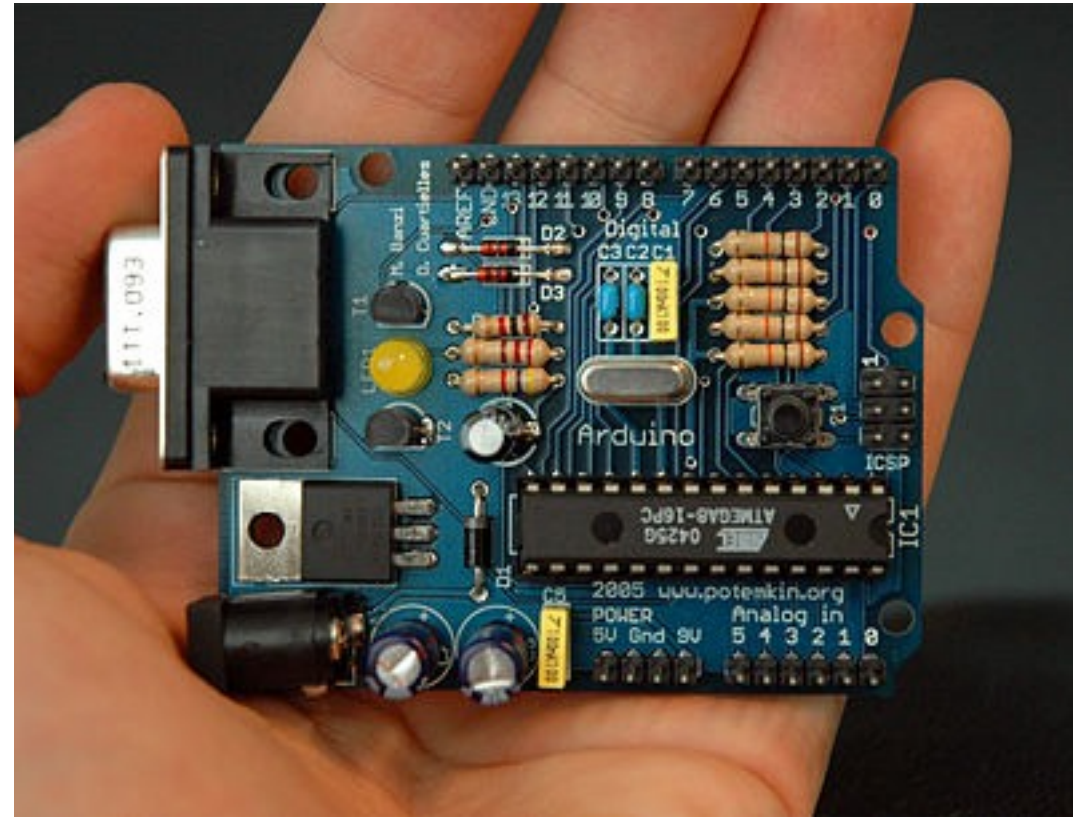

Un contexte : la naissance des Fab Lab (Fabrication Laboratory)

Idée née au Center for Bit and Atoms et MediaLab du MIT

Un atelier doté d'un jeu restreint de machines numériques pour fabriquer *presque* tout à la demande

adhésion nécessaire à la charte du M.I.T.

➔ **INTERDISCIPLINARITÉ**

➔ **OPEN SOURCE**

➔ **COLLABORATIF**

Des méthodes et des outils de création

Impression 3D
Numérisation
Moulage et composites
Prototypage électronique
Objets connectés

Documentation partagée
Outils web
Propriété intellectuelle

Numérique : sans danger

Accessible à tous, quelle que soit
la formation initiale

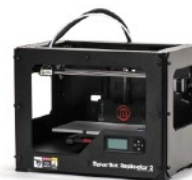

L'Arduino et les machines des FabLab

Rendre le matériel « libre » : fabriquer soi-même

Paradoxal :

- **simplifier pour les non-ingénieurs**
- **permettre de descendre au plus bas niveau**

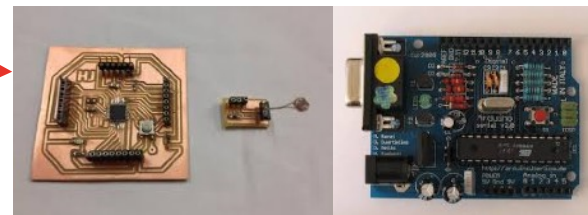

permet de fabriquer



brique essentielle



La prolifération d'Arduino

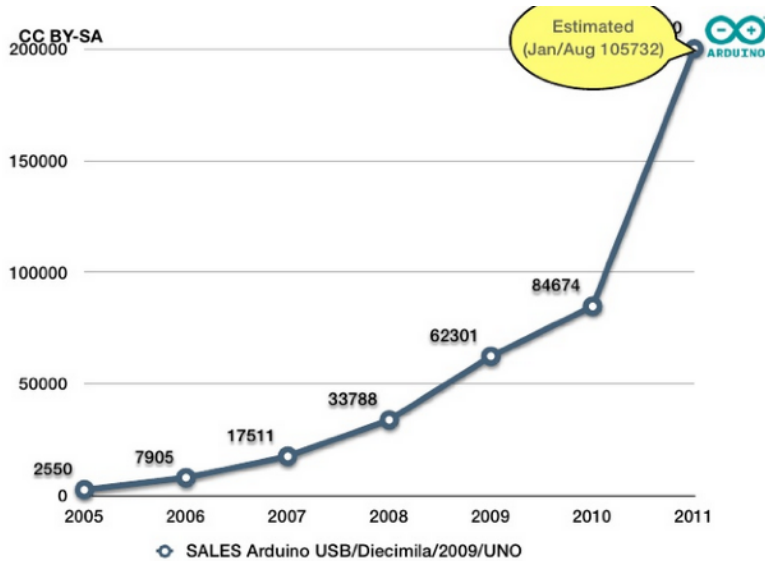

Leonardo (512 ko Flash+96 ko SRAM)



Due (plus d'entrées-sorties)



Ethernet



Micro



Nano



LilyPad

2

L'EXPÉRIENCE À SORBONNE UNIVERSITÉ(S)

Capteurs pour la chimie, la chimie physique et la physico-chimie

Pression



Température

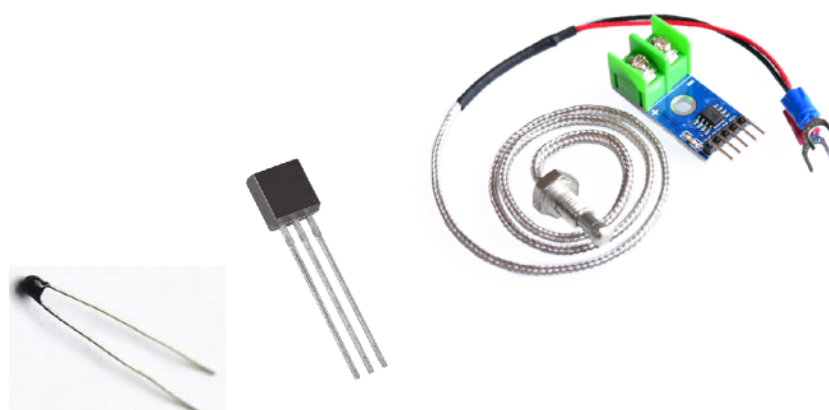

Température/humidité



Débit



Concentrations de gaz

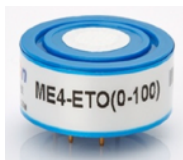

H₂S, Cl₂



EtOH



C_nH_{2(n+1)}



H₂



O₃



O₂



CO₂



CO

MH-Z16

MG811

Eau

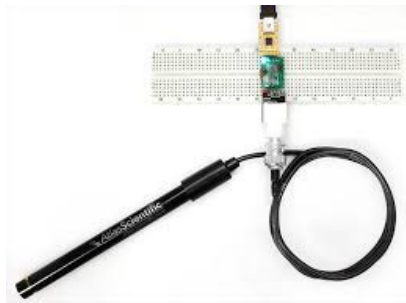

Gamme Grove de Seeedstudio

Capteurs avec interface I2C

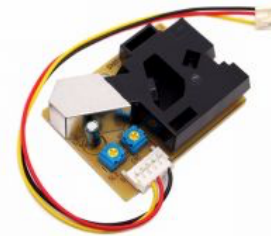
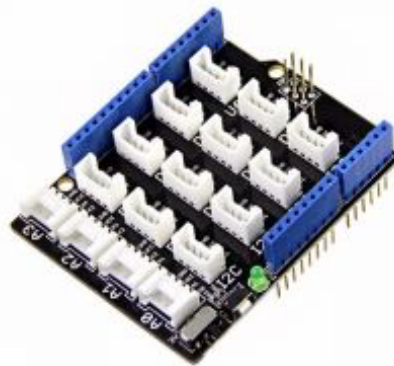

Plus « facile » - plus rapide - plus cher

Les enseignements développés

Mode projet

Par équipe

Interdisciplinaire

En autonomie

Du L1 au M2



Des instruments réalisés par des L1



pH mètre « étalonnage simplifié »

pousse-seringue

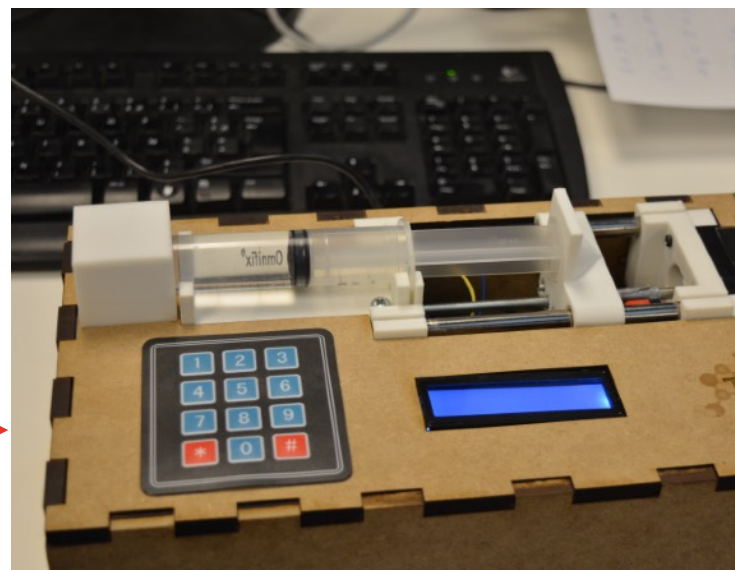

Des instruments réalisés par des L1

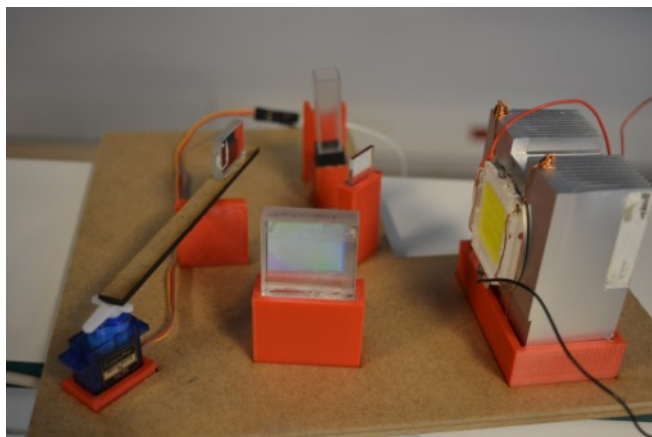

spectrographe



**titrimètre
automatique**

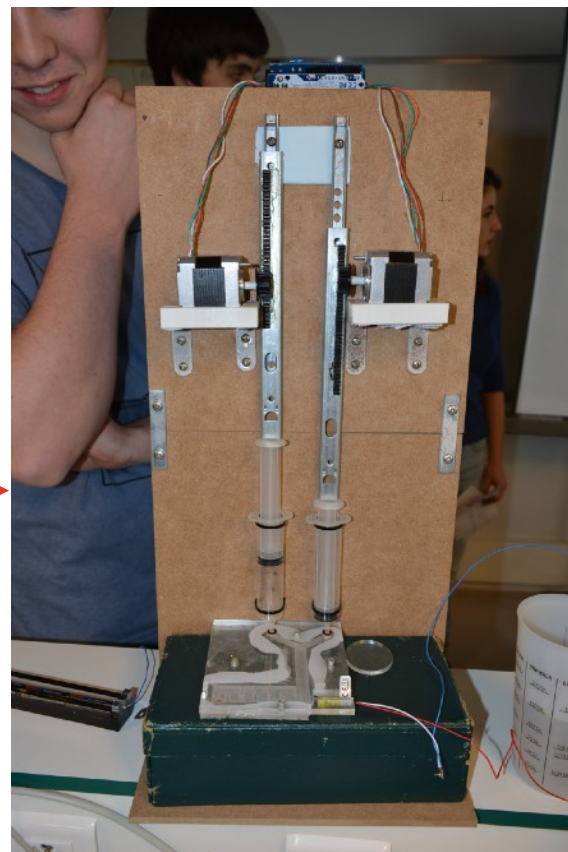

polarimètre



3

L'ÉCOSYSTÈME DES MICROCONTROLEURS PÉDAGOGIQUES

Mode programmé/ autonome (natif)

Langages :

- Arduino (Processing)
- C/C++
- Micropython
- Scratch sur certaines plateformes



programmation

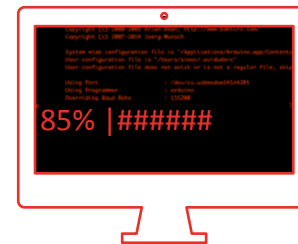

téléversement

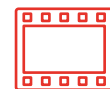
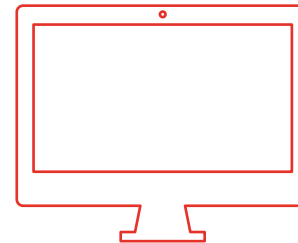
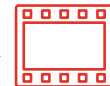

Mode interactif/ connecté (« *tethered* »)

Environnements :

- Processing
- LabView/Matlab
- Python
- Scratch et Scratch-likes
etc.

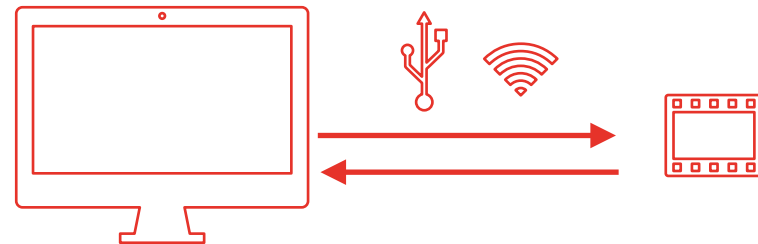

Des « concurrents »

BBC:Microbit



M5Stack



	BBC:Microbit	M5Stack
Wifi/Bluetooth	Oui	Oui
IDE Arduino	Non	Oui
Scratch-like	Oui	Oui
I2C-Grove	Extension	d'origine
Python	Micropython	Micropython et Python

Produire des écrits

fritzing

T I N
K E R
C A D

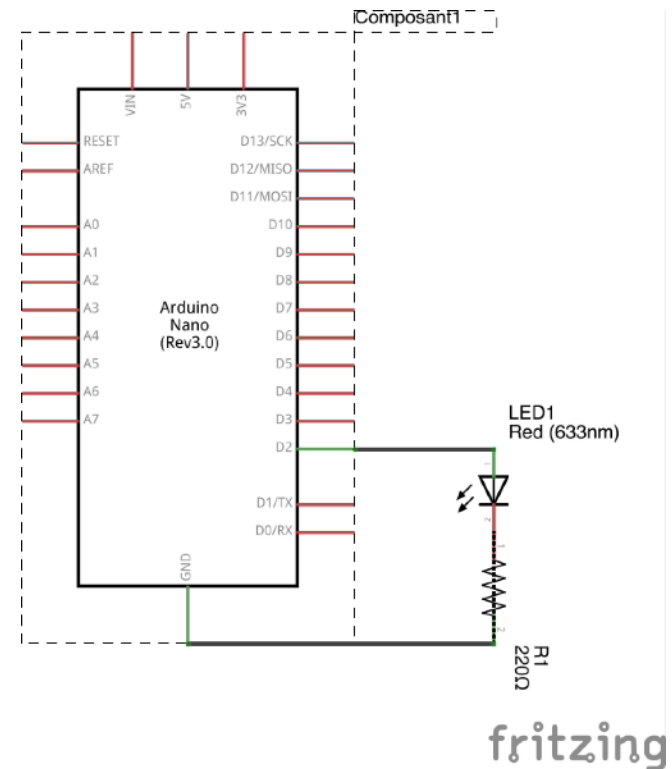
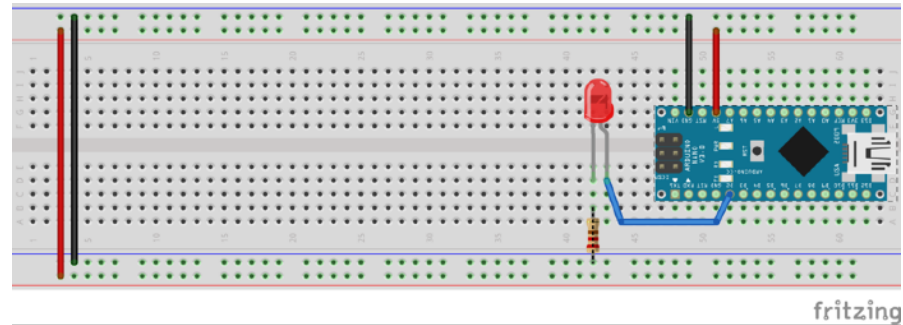

4

CONCLUSION PROVISOIRE

Les sources d'informations

Sites web :

arduino.cc

Instructables

Hackaday

Tiers Lieux Edu

Tribu ?

Practical methods for connecting physical objects.

3rd Edition

Making Things Talk



Learn by
Discovery

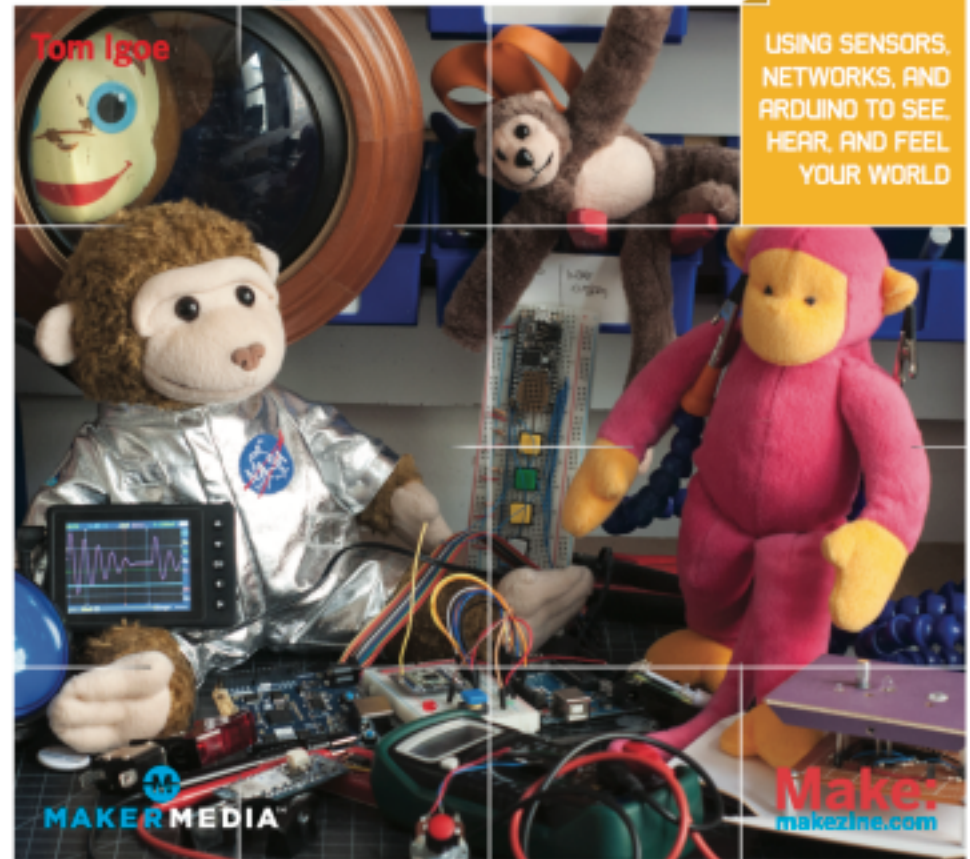

MERCI



Un réseau mondial

Plusieurs milliers de Fab
Lab « officiels »

